

QUAD Family

ARON™

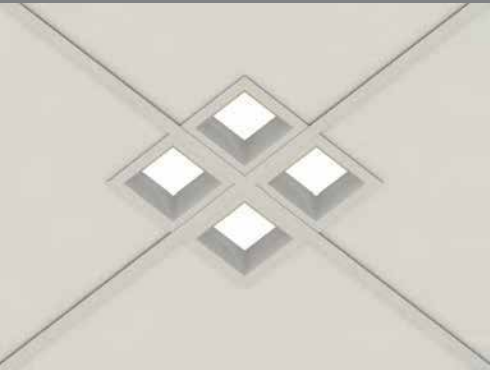

The **QUAD** Luminaire features a Patented mounting system over the intersection of the ceiling grid. The Quad is a modular Downlight fixture that allows for different configurations based on optical and aesthetic requirements.

SEE PAGE 6 For More Ordering Examples

*FASTSIZE tiles made-to-order through your Armstrong rep. Contact Armstrong for compatible tiles

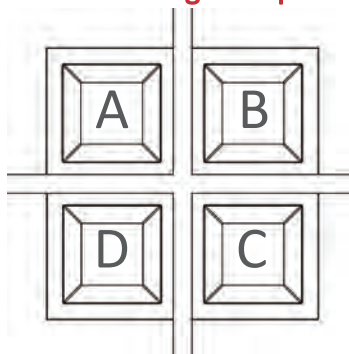

Project: _____
 Type: _____
 Notes: _____

5 Year Warranty



Patent - US Utility Patent # 10,859,242
 Patent - US Design Patent # D885650

Shown: QuadT1-FSQ-ARB240K8500-BRB240K8500-CRB240K8500-DRB240K8500-...

1. ARON ID

QUADT1
QUADT1 QUAD

2. CEILING TYPE

FSQ Flat Grid - Square Quadrants
SSSQ Screw Slot Grid - Square Quadrants
DWSQ Drywall Trim - Square Quadrants
 *DW Only Available in 4 or 1 quadrants - See QUAD SOLO

*Concealed grid intersection mounting is not supported

3. QUADRANT A

Light Source	CCT/CRI	Lumens
RB1	W35K8	500
-OR-		
Device	Add. Spec	

4. QUADRANT B

Light Source	CCT/CRI	Lumens
RB1	W35K8	500
-OR-		
Device	Add. Spec	

5. QUADRANT C

Light Source	CCT/CRI	Lumens
SLR	W35K9	1200
-OR-		
Device	Add. Spec	

6. QUADRANT D

Light Source	CCT/CRI	Lumens
-OR-		
Device	Add. Spec	

Light Source

- RB1** Regressed Lens - Beam 1 Medium
- RB2** Regressed Lens - Beam 2 Wide
*Reference Page 3 for beam distributions.
- DL** Drop Lens
* Specify Drop Length (.5", .75", 1")
*Reference Page 4 for Droplens
- SL** Spotlight
*Reference Page 9 and enter Spotlight Specification as separate line item on PO

- WW1** Wall Wash Beam 1
- WW2** Wall Wash Beam 2

*(N,E,S,W) Must Specify Direction of Light - See diagram On Page 5

*FOR NO QUADRANT - LIST "X" In Light Source

CCT/CRI

- W** Static White
*Specify CCT
27K8 - 2700K, 80CRI
27K9 - 2700K, 90CRI
30K8 - 3000K, 80CRI
30K9 - 3000K, 90CRI
35K8 - 3500K, 80CRI
35K9 - 3500K, 90CRI
40K8 - 4000K, 80CRI
40K9 - 4000K, 90CRI

-OR-
C RGBW

- *Specify White CCT
27K8 - 2700K, 80CRI
27K9 - 2700K, 90CRI
30K8 - 3000K, 80CRI
30K9 - 3000K, 90CRI
35K8 - 3500K, 80CRI
35K9 - 3500K, 90CRI
40K8 - 4000K, 80CRI
40K9 - 4000K, 90CRI

*Only Available for R & DL & WW Light Sources

*Contact Factory C2 - Custom Trim & Bevel

Quadrant Lumens

- 125** 125 lm @ 1.5 W
- 250** 250 lm @ 3.1 W
- 400** 400 lm @ 4.8 W
- 500** 500 lm @ 6.0 W
- 750** 750 lm @ 9.0 W
- 1000** 1000 lm @ 12.1 W

**Contact factory for different lumen packages within the same fixture (i.e) ARB1W30K8500_BRB1W30K8300
 **Quadrant Wattage Taken @ 35K8 with RB1 Lensing
 **For Spotlight Lumen Packages, Refer to Page 9

*FOR NO QUADRANT - LIST "X" In Light Source

IoT

- SPK** Speaker
*Reference Page 11 and enter Speaker Code in Add. Spec
- SNR** Sensor
*Reference Page 13 and enter Sensor Code in Add. Spec
- SEC** Security
*Contact Factory For Details Security Camera Code in Add. Spec

*Contact Factory For Different Paint Color Options of IoT Devices - White Color Standard

7. VOLTAGE

- EX. UNV
- UNV** 120-277V
 - 347** 347V
 - POE** Power over Ethernet

8. DRIVER/CONTROL

- EX. DM
- DM** Factory 0-10V Dim 1%
 - BT** Bluetooth
 - DALI** Dali System
 - DMX** DMX System
- **See Page 3 for Bluetooth Information. Consult Factory

9. FINISH

- EX. W
- W** Matte White
 - BLK** Matte Black
 - C1** Custom Color (Specify RAL)
 - C2** Custom Color (Trim & Bevel Different Colors)
*Contact Factory C2 - Custom Trim & Bevel

10. EM/OPTIONS

- EM10
- E10W** Emergency 10W; Integral
 - ICC** Independent Quadrant Dimming Control (Max 2 Dimming Channels)
 - CP** Chicago Plenum

EXAMPLE Fixture

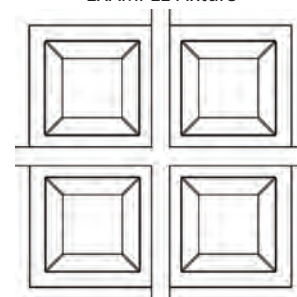

QuadT1-FSQ-ARB1W35K8500-BRB1W35K8500-CRB1W35K8500-DRB1W35K8500-UNV-DM-W

ARON Lighting reserves the right to make any design changes for continuous improvement which will not affect the overall appearance, performance or pricing.

Housing Types

Flat Housing

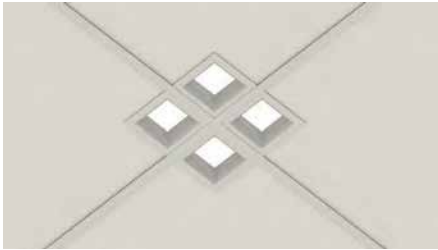

- Notate "FSQ" in Ordering Guide
- Designed for Flat 9/16" & 15/16" Grids

Screw Slot Housing

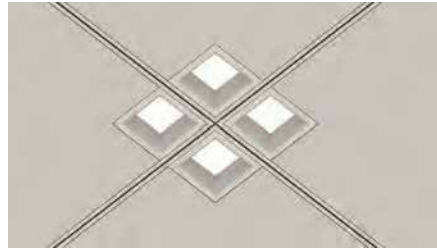

- Notate "SSSQ" in Ordering Guide
- Designed for Dimensional 9/16" Grids

Drywall Housing



- Notate "DWSQ" in Ordering Guide

Dimensions

Flat Housing

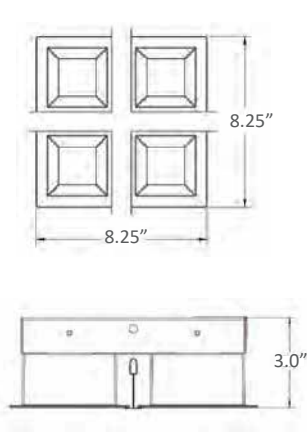

Screw Slot Housing

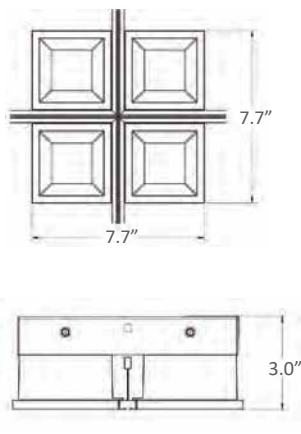

Drywall Housing

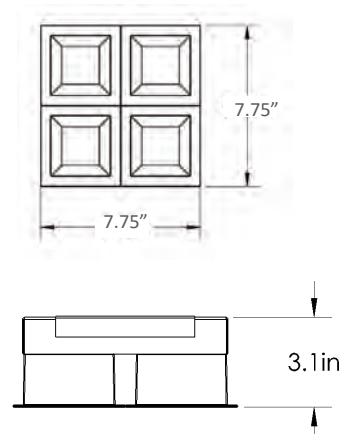

EM Housing

**Height Dimension for all housing Types with EM Battery*

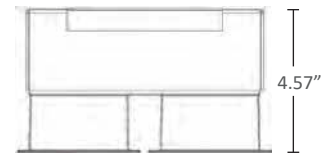

**Used for RGBW & EM Options*

Construction

- Cast Aluminum housing
- Powder coated paint
- Galvanized sheet metal components
- Mate with Flat 15/16", 9/16" and Dimensional 9/16" TBars

Optical

- Symmetric and asymmetric distributions
- Coated Acrylic light guide
- Coated Acrylic diffuser
- Minimum 80 or 90 CRI
- 3000K, 3500K, 4000K
- ≤ 3 SDCM

Electrical

- Integral high efficiency driver
- 0-10V dimming (1%) standard
- Class 2
- Optional remote battery pack

Weight

- 4Q = 10 lbs
- 3Q = 8.5 lbs
- 2Q = 7.0 lbs
- 1Q = 5.5 lbs

Beam Options

Contact factory for custom configurations

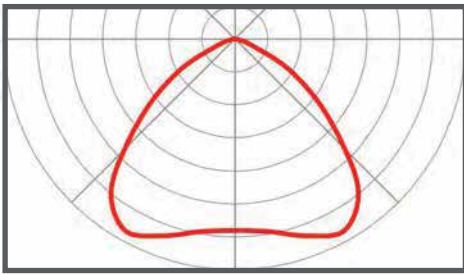

RB1 - Medium

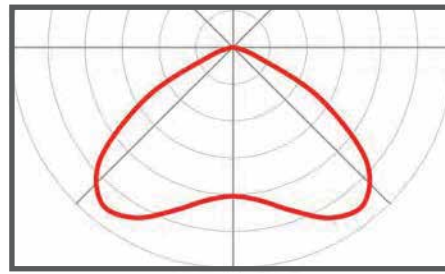

RB2- Wide

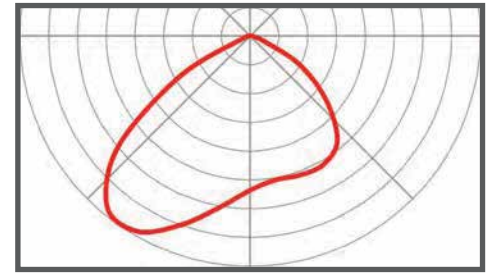

WW- Wall Wash Asymmetric

*See Page X

Fixture Wattages

*Fixture Wattage Tested with RB2 Lensing

Lumens/Quadrant	Watts/Quadrant
125	1.53
250	3.0
500	6.0
750	9.0

Lumens/Fixture	Watts/Fixture
750	9.0
1000	12.0
1500	18.1
2000	24.1
2500	30.1
3000	35.8

Bluetooth Technology



With our BubblyNet OEM partnership, realize the power of bluetooth lighting control! Offering wall controllers, integrated fixture sensors, tunable white/ rgbw control. Contact Factory for More Information



PoE Technology



Our Partnerships with Igor and NuLEDs offer PoE Integration using low voltage cat 5, cat 6 cabling. Contact Factory For more Information.

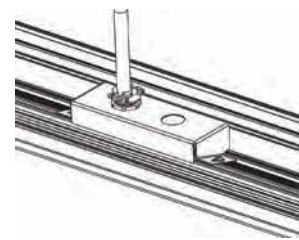

Lens Options

Drop Lens

The QUAD offers a new and unique look with its drop lens option. Made from thermoformed acrylic optimum light diffusion material, the drop lens creates a dimensional look within the ceiling while providing functional lighting. Drop lens lengths available in .5", .75", and 1"

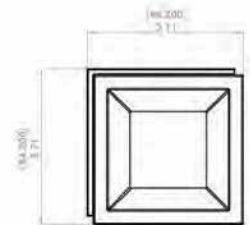
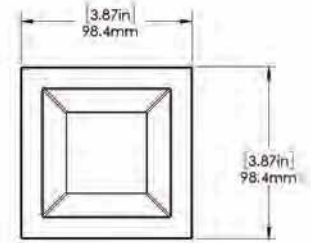
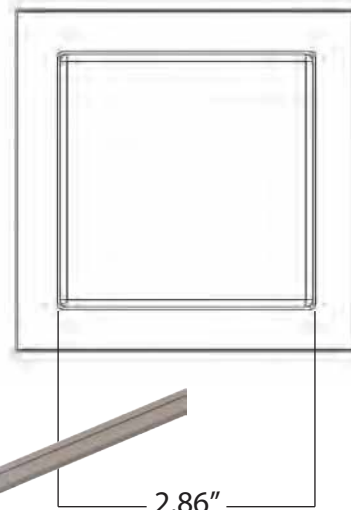
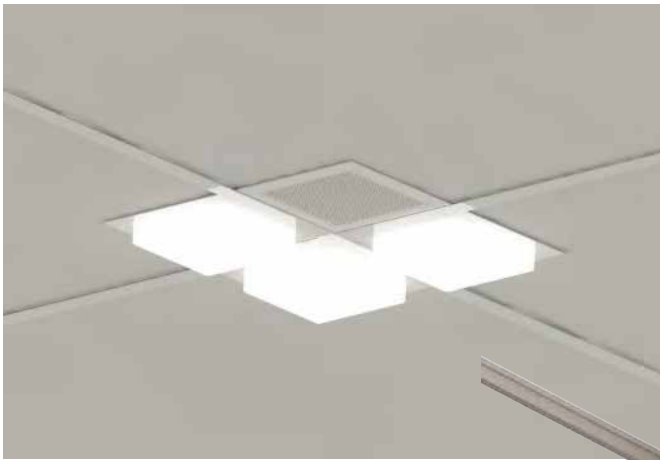

QuadT1-FSQ-ASP-K-BDL1"35K8500
-CDL1"35K8500-DDL1"35K8500

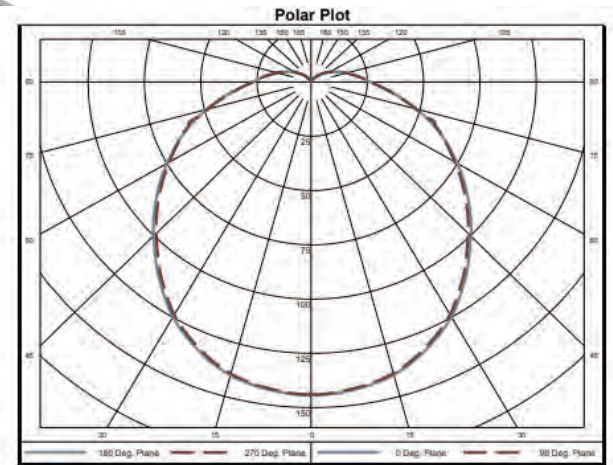

Model Tested:

QUADT1-FSQ-DL1-500-B3-35K8-UNV-DM-W

**SEE QUAD SOLO CUT SHEET

Zone	Lumens	% of Luminaire
0-40	187	32.7%
0-60	341	59.8%
0-90	504	88.3%
90-180	67	11.7%

Zonal Lumen Summary

Zone	Lumens	% of Luminaire	Zone	Lumens	% of Luminaire	Zone	Lumens	% of Luminaire
0-5	3.44	0.6%	60-65	35.34	6.2%	120-125	3.64	0.6%
5-10	10.21	1.8%	65-70	32.89	5.8%	125-130	2.57	0.4%
10-15	16.72	2.9%	70-75	29.60	5.2%	130-135	1.72	0.3%
15-20	22.73	4.0%	75-80	25.49	4.5%	135-140	1.04	0.2%
20-25	28.00	4.9%	80-85	21.58	3.8%	140-145	0.53	0.1%
25-30	32.44	5.7%	85-90	17.96	3.1%	145-150	0.21	0.0%
30-35	35.72	6.3%	90-95	14.96	2.6%	150-155	0.07	0.0%
35-40	37.83	6.6%	95-100	12.37	2.2%	155-160	0.04	0.0%
40-45	38.92	6.8%	100-105	10.16	1.8%	160-165	0.04	0.0%
45-50	39.28	6.9%	105-110	8.22	1.4%	165-170	0.03	0.0%
50-55	38.73	6.8%	110-115	6.48	1.1%	170-175	0.02	0.0%
55-60	37.36	6.5%	115-120	4.95	0.9%	175-180	0.01	0.0%

Lens Options

Wall Wash

General / Dimensions:

Material: Die Cast aluminum Casing, Powder Coat Finish

Applications: Retail, Corridor, Restaurants, Commercial

Dimensions:

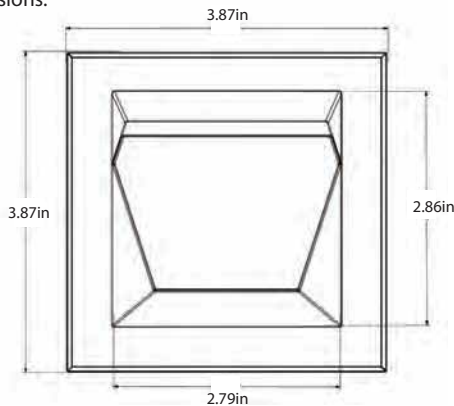

Description

The QUAD Tbar Wall Wash Quadrant allows for great illumination across the vertical plane. The QUAD Wall Wash can be specified in a multi-directional form factor - see below for proper ordering instructions and examples.

Example Product Codes:



Page 1 QUAD Fixture Product Code:

QUADT1-FSQ-ARB1W35K8500-BRB1W35K8500-CWW1SW35K8500-DWW1SW35K8500-UNV-DM-W



Page 1 QUAD Fixture Product Code:

QUADT1-FSQ-AX-BX-CWW1SW35K8500-DRB1W35K8500-500-B2-35K8-UNV-DM-W

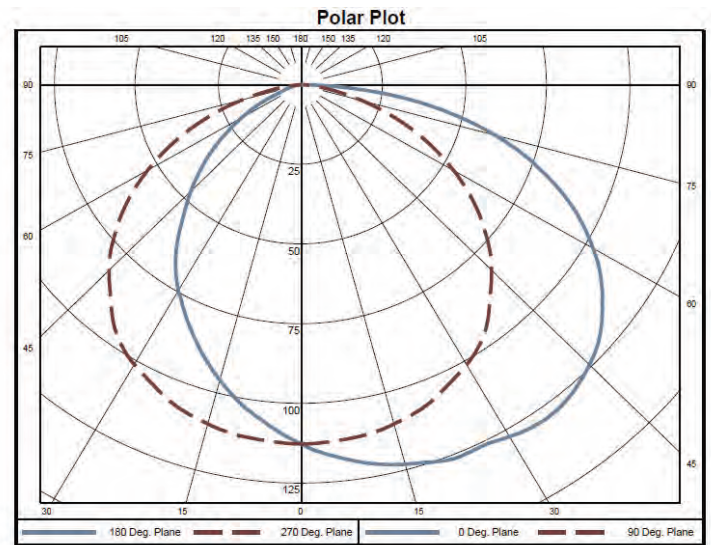

Zone	Lumens	% of Luminaire
0-40	151	41.6%
0-60	277	76.6%
0-90	361	100.0%
90-180	0	0.0%

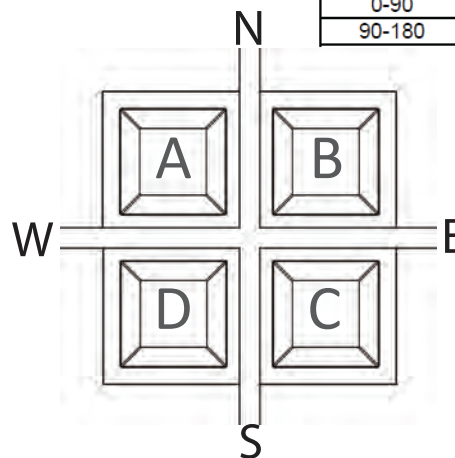

Specify Direction of the Wall Wash Quadrant In relation to the Fixture:
For Example, if Wall Wash quadrant is specified in Quadrant C, Specify if this will face North, East, South, or West

QUAD Family



Sample Configurations & Ordering Guide

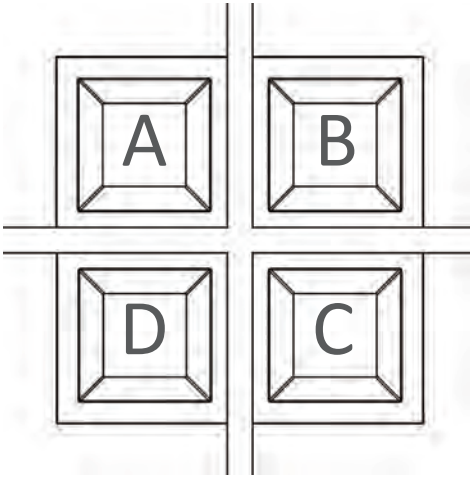

- Match labeled quadrant with corresponding column on ordering guide.

- Notate "RB1, RB2" to use quadrant with regressed lens.

-Notate "SL" to use quadrant with Spotlight

-Notate "DL" And Specify Drop Length to use quadrant with Drop Lens

-Notate "WW1, WW2" to use quadrant with Wall Wash Lensing (Must Specify Direction of light using (N,E,S,W)).

-If choosing a lighting application quadrant, specify CCT & Lumens Per Quadrant

-If choosing an IoT Application notate "SPK, SNR, SEC" And list any additional IoT device specification in quadrant

- Notate "X" to omit quadrant from fixture.

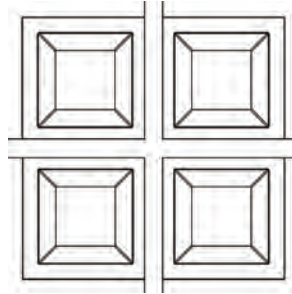

QuadT1-FSQ-ARB1W35K8500-BRB1W35K8500-CRB1W35K8500-DRB1W35K8500.....

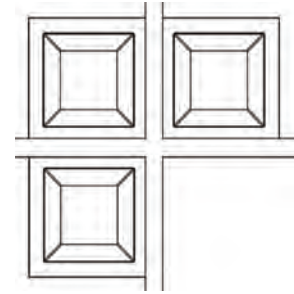

QuadT1-FSQ-ARB1W35K8500-BRB1W35K8500-CX-DRB1W35K8500.....

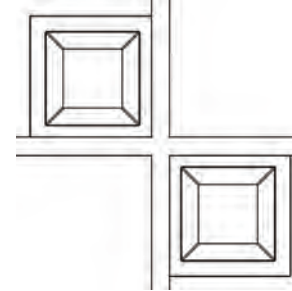

QuadT1-FSQ-ARB1W35K8500-BX-CRB1W35K8500-DX.....

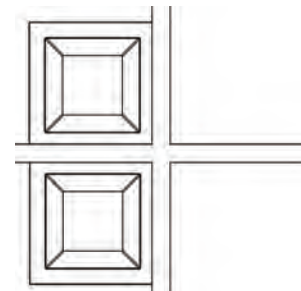

QuadT1-FSQ-ARB1W35K8500-BX-CX-DRB1W35K8500.....

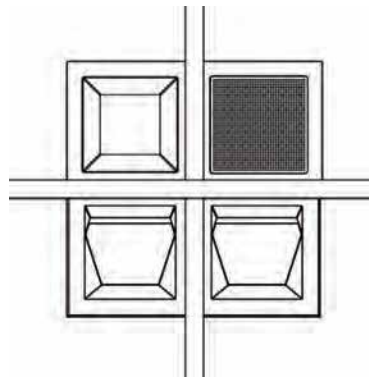

QuadT1-FSQ-ARB1W35K8500-BSPK-CWW1SW35K8750-DWW1SW35K8750.....

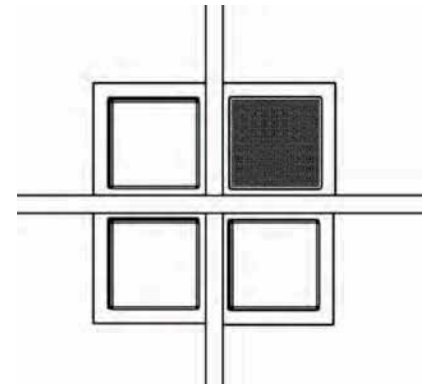

QuadT1-FSQ-ADL1"3W5K81000-BSPK-CDL1"35K81000-DDL1"35K81000.....

Important Ordering Notes:

For Armstrong Custom Tile Program - please see page 7 and coordinate with EC/GC

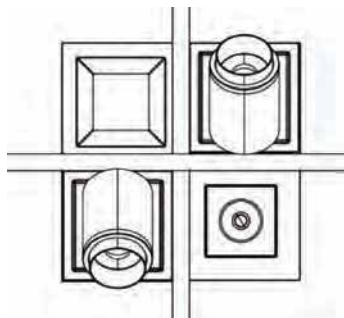

QuadT1-FSQ-ARB1W35K8500-BSLW35K91000-CSNR-DSLW35K8500.....

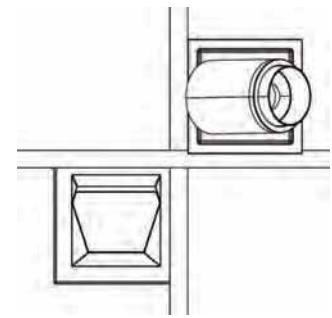

QuadT1-FSQ-AX-BSL35K91000-CX-DWW1SW35K8750.....

Notes:
- Coordinate lighting fixture install with ceiling contractor
- Contact your local Armstrong representative for Made-To-Order ceiling tiles. (See page 6)



QUAD Family



Model Tested: QuadT1-FSQ-ARB1W35K8400-BRB1W35K8400-CRB1W35K8400-DRB1W35K8400-UNV-DM-W

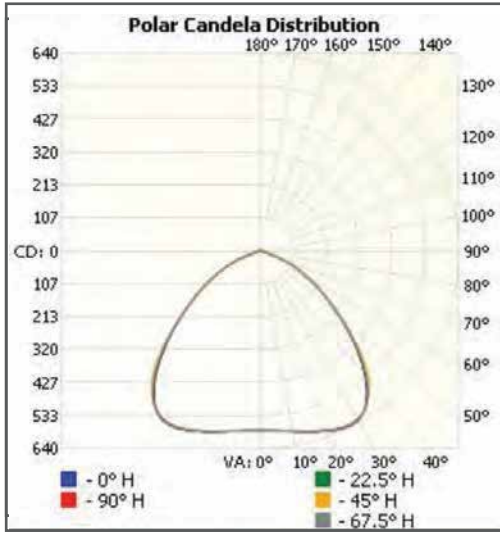

Configuration: 4 Quadrant
Lumens/Quadrant: 403
Total Lumens: 1613
Input Watts: 19.77 W
Efficacy: 81.6 lm/W

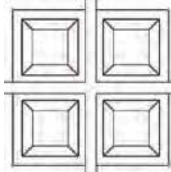

Vertical Angle	Horizontal Angles				
	0	22.5	45	67.5	90
0	582	582	582	582	582
5	585	585	585	584	585
10	594	593	593	592	593
15	606	606	604	604	606
20	620	620	618	619	621
25	633	632	629	631	633
30	631	629	628	629	632
35	598	598	602	600	599
40	526	530	543	532	528
45	433	437	451	441	437
50	337	340	340	344	340
55	250	256	249	259	253
60	180	189	177	187	182
65	122	124	121	127	122
70	59	67	70	69	60
75	21	22	27	22	21
80	11	11	11	11	11
85	3	3	3	3	3
90	0	0	0	0	0

Zonal Lumens		
Zone	Lumens	% Luminaire
0-10	56.1	3.5
10-20	172.0	10.7
20-30	291.1	18.0
30-40	370.9	23.0
40-50	338.0	20.9
50-60	229.2	14.2
60-70	122.3	7.6
70-80	29.9	1.9
80-90	4.4	0.3

Model Tested: QuadT1-FSQ-ARB1W35K8400-BX-CX-DRB1W35K8400-UNV-DM-W

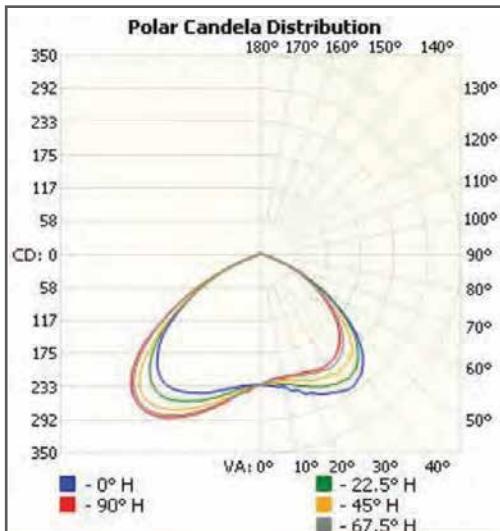

Configuration: 2 Quadrant Parallel
Lumens/Quadrant: 422
Total Lumens: 845
Input Watts: 9.76 W
Efficacy: 86.6 lm/W

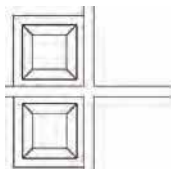

Vertical Angle	Horizontal Angles				
	0	22.5	45	67.5	90
0	229	229	229	229	229
5	232	225	227	223	221
10	236	233	226	223	219
15	247	239	229	221	220
20	260	248	237	225	221
25	271	257	241	230	226
30	279	264	244	234	227
35	283	267	244	231	223
40	273	260	241	221	212
45	253	240	225	202	194
50	218	210	190	174	168
55	170	166	146	140	134
60	122	120	105	104	100
65	76	76	68	68	67
70	33	38	38	37	34
75	13	13	16	14	14
80	7	7	7	8	8
85	2	2	2	3	3
90	0	0	0	0	0

Zonal Lumens		
Zone	Lumens	% Luminaire
0-10	22.3	2.6
10-20	70.5	8.3
20-30	125.3	14.8
30-40	177.5	21
40-50	197.1	23.3
50-60	155.2	18.4
60-70	77.3	9.1
70-80	17.2	2
80-90	2.9	0.3



Spotlight Ordering Guide

Beam Adjustable Ordering Code

PRODUCT ID		CCT		LUMENS		FINISH		DIMMING	
Spotlight - Field Adj	SP01	27K9	2700K - 90CRI	1200	lumens (BA)	W	White	STD	No Dim
		30K9	3000K - 90CRI			BLK	Black		
		35K9	3500K - 90CRI			SLV	Silver		
		40K9	4000K - 90CRI						



Description

The QUAD Tbar Spotlight offers a unique solution to grid mounted accent lighting. Easily mount the fixture with or without other downlight quadrants at the intersection of any TBar grid system. There are multiple configurations available, with the ability to have 4 spotlights in 1 fixture.

We have Two OEM partners for our spotlight solution. The first, by LPA, offers a field adjustable beam angle, 14-50°, with high CRI. Available in 2700K-4000K. Obtain the perfect aim illumination angle for any solution with full horizontal rotation and up to 90° verticle adjustability.

Our Second, by Bruck Lighting, Offers various static beam angles, with different lumen outputs. The GX series offers variable accent light solutions while achieving an architecturally clean look in the QUAD Tbar Housing.

No more track needed - just drop the fixture on the TBar.

GX Series Ordering Code

PRODUCT ID		CCT		LUMENS		FINISH		BEAM ANGLE		DIMMING	
Spotlight -		27K9	2700K - 90CRI	900	lumens (GX10)	W	White	20	20 Degrees	STD	No Dim
		30K9	3000K - 90CRI	1150	lumens (GX15)	BLK	Black	38	38 Degrees		
		35K9	3500K - 90CRI	1800	lumens (GX25)	SLV	Silver	60	60 Degrees		
		40K9	4000K - 90CRI								

Include the Quantity and Product ID on Purchase Order Beneath
QUAD Product Ordered
** See Example Product Codes

For More Information or Further Ordering Questions,
Please Consult Factory

Beam Adjustable (BA) General / Dimensions:

- Light Output: Up to 1200lm
- Material: Die Cast aluminum Casing, Powder Coat Finish
- Aiming: 350° Horizontal Coverage and 90° Vertical Rotation
- Field Adjustable Beam: 14-50°
- Integral Driver
- Limited Warranty: 5 years
- LED Type: CREE CMA 1200 lm Chip

Dimensions:

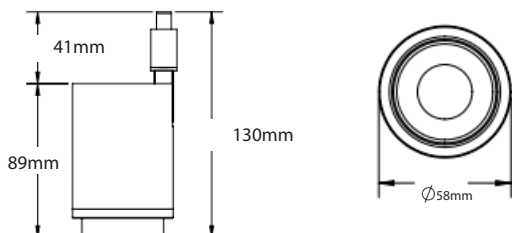

GX Series General / Dimensions:

- Light Output: 900lm, 1150lm, 1800lm Options
- Material: Die Cast aluminum Casing, Powder Coat Finish
- Aiming: 350° Horizontal Coverage and 90° Vertical Rotation
- Static Beam : 20°, 38°, 60° Options
- Integral Driver
- Limited Warranty: 5 years



Spotlight Ordering Guide

Beam Adjustable (BA) Photometric and Performance Data

Input Voltage: 220
 Wattage: 15W
 Efficiency: 64.14 lm/W
 Current: 710mA

Polar Candela Distribution

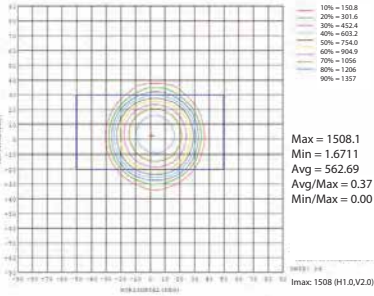

Illuminance Cone Distribution

Height	Eavg,Emax	Angle: 51.19deg	Diameter
Flux out: 732.1 lm			
1 m	979.6,15051x		95.80 cm
2 m	244.9,376.31x		191.60 cm
3 m	108.8,167.21x		287.40 cm
4 m	61.22,94.061x		383.20 cm
5 m	39.18,60.201x		479.00 cm
6 m	27.21,41.811x		574.80 cm
7 m	19.99,30.721x		670.60 cm
8 m	15.31,23.521x		766.40 cm
9 m	12.09,18.581x		862.20 cm
10 m	9.796,15.051x		958.00 cm



Example Product Codes:



Page 1 QUAD Fixutre Product Code:

QUADT1-FSQ-ASL-BX-CX-DX-500-B2-35K8-UNV-DM-W

Page 7 Spotlight Product Code:

(qty:1) SP01-40K90-1500-W-ND



Page 1 QUAD Fixutre Product Code:

QUADT1-FSQ-AR-BR-CSL-DSL-500-B2-35K8-UNV-DM-W

Page 7 Spotlight Product Code:

(qty:2) SP01-35K9-1500-W-ND

Speaker Ordering Guide

Speaker Addons	
ARON PO ID	
Sub:	SB-01
Receiver:	RE-01
Mixer:	MIX-01



General / Dimensions:

Broad Coverage Pattern: 160°

Material: Die Cast aluminum Casing, Powder Coat Finish

Driver: 60 mm (2.5 in) mid/high driver with butyl rubber surround
16-ohm allows for parallelling of multiple units on a low-Z amplifier

Applications: Retail, Corridor, Restaurants, Commercial

Grill: Many options in color and dimension for a reveal or flush aesthetic

Sub: Designed to be paired with 40CS/T subwoofer-satellite system

Dimensions:

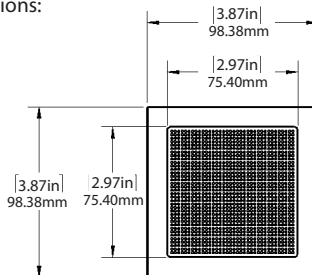

Description

The QUAD Tbar Speaker offers a unique solution to grid mounted sound solutions. Easily mount the speaker with or without other downlight quadrants at the intersection of any TBar grid system. There are multiple configurations available, recommended to have one speaker in one fixture..

No more need for cluttered ceilings at the center of the tile - just drop the fixture and speaker on the TBar. Only a single dropdown required for these various technologies!

Our speaker partner, JBL, is well renowned within the sound industry. This integrated partnership pairs great light quality with equally competitive sound quality in quite a small form factor.



Example Product Codes:



Page 1 QUAD Fixture Product Code:

QUADT1-FSQ-ASPK-BR-CR-DR-500-B2-35K8-UNV-DM-W



Page 1 QUAD Fixture Product Code:

QUADT1-FSQ-ASPK-BX-CX-DX-500-B2-35K8-UNV-DM-W

***Subwoofer, Receiver, and Mixer Available**

Speaker Ordering Guide

Specifications and Performance Data

System:

- Frequency Range (-10 dB): 140 Hz - 20 kHz
- Frequency Response (± 3 dB): 180 Hz - 17 kHz 1m/W
- Power Capacity: 30W Continuous Program Power
15W Continuous Pink Noise
- Nominal Sensitivity (2.83V/1m): 82 dB
- Nominal Coverage Angle: 160° conical coverage
- Directivity Factor (Q): 6.6
- Directivity Index (DI): 6.8 dB
- Rated Maximum SPL: 94 dB @ 1m (3.3 ft) average, 114 dB peak
- Rated Impedance: 16 ohms

Transducer

Driver: 60 mm (2.5 in) with polypropylene cone, butyl rubber surround, copper-clad coil, vented aluminum former



Beamwidth:

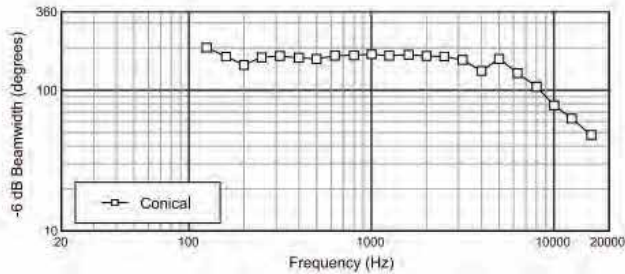

Frequency Response:

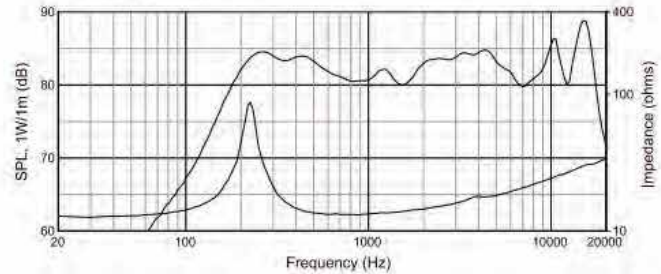

Half-space (2pi, mounted in ceiling)

Directivity Index:

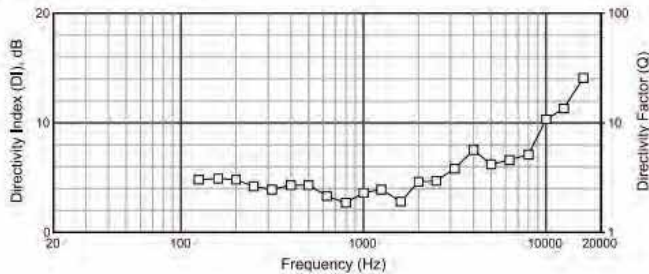

Off-Axis Frequency Response:

