

QUAD SOLO

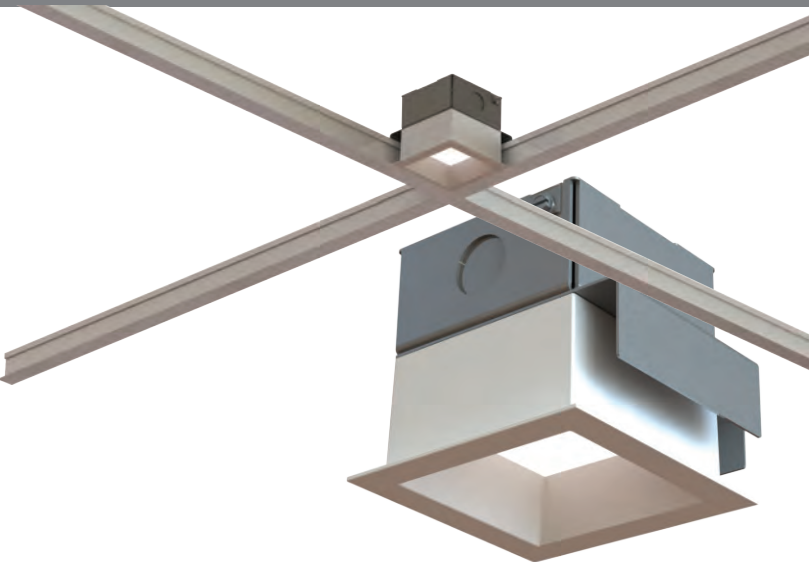

Shown: QuadT1-FSQ-R-...

Project: _____

Type: _____

Notes: _____

The **QUAD** SOLO Luminaire features a Patented mounting system over the intersection of the ceiling grid. The Quad Solo also mounts easily in drywall with a simple spring clip design and can be mounted in the center of ceiling panels.



Patent - US Utility Patent # 10,859,242
Patent - US Design Patent # D885650

Ordering Guide



QuadT1			
ARON ID	MOUNTING	QUAD TYPE	LUMENS
QuadT1 SQUARE SOLO	F Flat Grid	R Regressed Lens	250 250 Lumens @ 3.0W
	SS Screw Slot Grid	DL Drop Lens *Specify Length .5" .75" 1"	500 500 Lumens @ 6.0W
	GYP Gypsum Ceiling	WW Wall Wash	750 750 Lumens @ 9.1W
	P Center of Ceiling Panel	SL Spotlight	1000 1000 Lumens @ 13.1W
		SPK Speaker	
		SNR Sensor	

**For Drop Lens Ordering Guide, please see page 4

**For Wall Wash Ordering Guide, please see page 5

Important Ordering Notes:
For Armstrong Custom Tile Program - please see page 6 and coordinate with EC/GC



BEAM		COLOR / CRI		VOLTAGE		DRIVER		FINISH		EM/ACCESSORIES	
B1 Medium		27K8 2700K - 80CRI		UNV 120 - 277V		DM Factory 0-10V Dim 1%		W White		E5W 5W EM Battery	
B2 Wide		30K8 3000K - 80CRI		347 347V		BT Bluetooth Control		BLK Matte Black		E10W 10W EM Battery	
		35K8 3500K - 80CRI		POE Power over Ethernet		DMX DMX Control			C Custom Color		CP Chicago Plenum
		40K8 4000K - 80CRI					LD2 Lutron DALI-2				
		27K9 2700K - 90CRI				LDE1 Lutron EcoSystem (1% Dimming)				AWN S Athena Wireless Node with Sensors	
		30K9 3000K - 90CRI				PEQ0 Lutron EcoSystem (0.1% Dimming)					
		35K9 3500K - 90CRI									
		40K9 4000K - 90CRI									
		RGBW RGBW									

**Beam For Regressed Lens Option Only.

**EM Batteries are Removed
Add all Accessories/EM At the End of the Product Code.

Mounting Types

Flat TBar Mounting



- Notate "FSQ" in Ordering Guide
- Designed for Flat 9/16" & 15/16" Grids

Screw Slot TBar Mounting



- Notate "SSSQ" in Ordering Guide
- Designed for Dimensional 9/16" Grids

Drywall - Trim



- Notate "GYP" in Ordering Guide
- Designed for all Hard Lid Ceilings Spring Clip Installation

Center of Panel

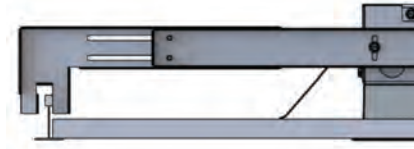

- Notate "P" in Ordering Guide
- Designed for Any Panel Size

Dimensions

Grid

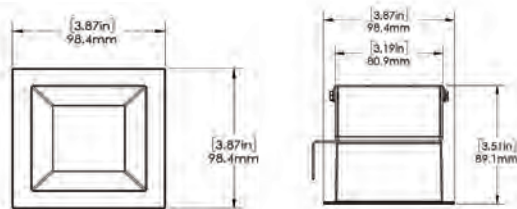

Drywall

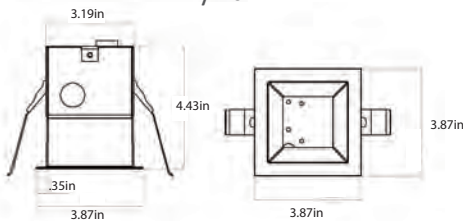

Center of Panel

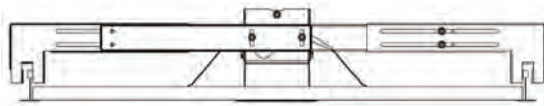

High Lumen Output

*Used for Lumen Outputs >=750lm

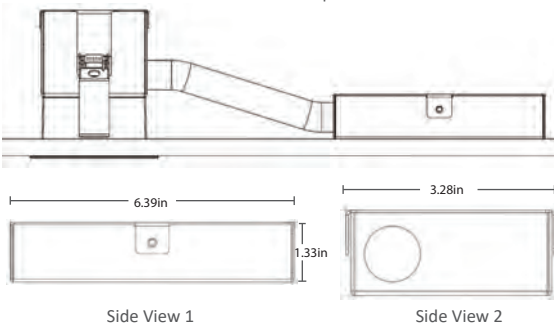

Beam Options

With an Edge Lit optical system, ARON Lighting's diffusion technology enables different beam options to fit various downlight applications.

*Available only for the Regressed Lens Type.

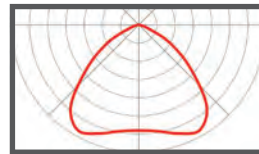

B2 - Medium

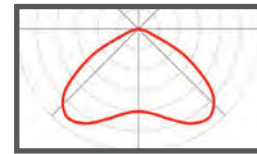

B3 - Wide

Bluetooth Technology



With our BubbyNet OEM partnership, realize the power of bluetooth lighting control! Offering wall controllers, integrated fixture sensors, tunable white/ rgbw control. Contact Factory for More



PoE Technology



Our Partnerships with Igor and NuLEDs offer PoE Integration using low voltage cat 5, cat 6 cabling. Contact Factory For more Information.

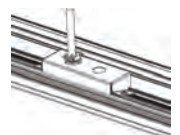

Construction

- Cast Aluminum housing
- Powder coated paint
- Galvanized sheet metal components
- Mate with Flat 15/16", 9/16" and Dimensional 9/16" TBars
- Drywall and Center of Panel Installation
- Weight = 4.7 lbs

Optical

- Various Beam distributions
- Coated Acrylic light guide
- Coated Acrylic diffuser
- Thermoformed Diffuse Drop Lens
- Minimum 80 or 90 CRI
- 3000K, 3500K, 4000K
- ≤ 3 SDCM

Electrical

- Integral high efficiency driver
- 0-10V dimming (1%) standard
- Class 2
- Optional remote battery pack

Model Tested: QuadT1-GYP-R-500-B2-35K8-UNV-DM-W

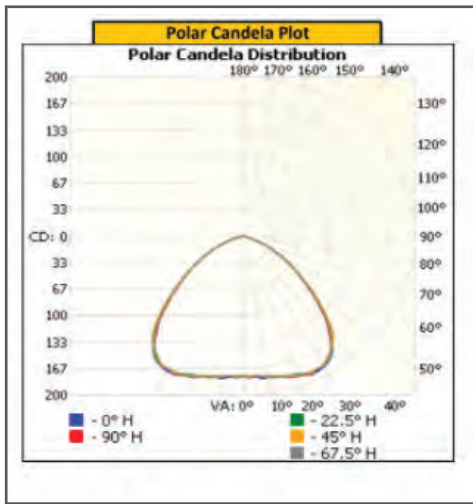

Angle	0	22.5	45	67.5	90
0	176	176	176	176	176
5	177	176	176	176	177
10	180	180	179	179	179
15	182	182	183	183	183
20	186	185	187	188	187
25	190	190	187	190	192
30	189	188	187	189	189
35	181	180	177	178	179
40	161	159	163	158	155
45	132	132	134	130	127
50	102	102	101	101	98
55	76	77	74	75	73
60	54	55	52	54	52
65	36	37	35	36	34
70	18	20	20	19	16
75	6	6	8	6	6
80	3	3	3	3	3
85	1	1	1	1	1
90	0	0	0	0	0
95	0	0	0	0	0
100	0	0	0	0	0
105	0	0	0	0	0
110	0	0	0	0	0
115	0	0	0	0	0
120	0	0	0	0	0
125	0	0	0	0	0
130	0	0	0	0	0
135	0	0	0	0	0
140	0	0	0	0	0
145	0	0	0	0	0
150	0	0	0	0	0
155	0	0	0	0	0
160	0	0	0	0	0
165	0	0	0	0	0
170	0	0	0	0	0
175	0	0	0	0	0
180	0	0	0	0	0

Zone	Lumens	Luminaire
0-30	156.0	32.5%
0-40	266.6	55.5%
0-60	434.6	90.5%
60-90	45.7	9.5%
70-100	10.1	2.1%
90-120	0.0	0.0%
0-90	480.3	100.0%
90-180	0.0	0.0%
0-180	480.3	100.0%

Configuration: 1 Quadrant
Lumens/Quadrant: 480
Total Lumens: 480
Input Watts: 9 W
Efficacy: 53.4 lm/W

Entire luminous intensity matrix found in .IES file

Model Tested: QuadT1-FSQ-ARB1W35K8400-BRB1W35K8400-CRB1W35K8400-DRB1W35K8400-UNV-DM-W

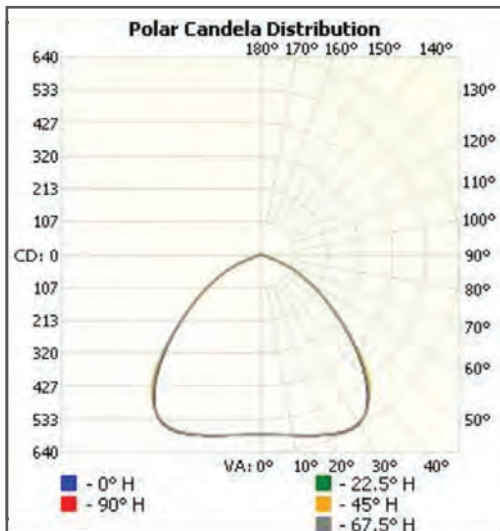

Vertical Angle	Horizontal Angles				
	0	22.5	45	67.5	90
0	582	582	582	582	582
5	585	585	585	584	585
10	594	593	593	592	593
15	606	606	604	604	606
20	620	620	618	619	621
25	633	632	629	631	633
30	631	629	628	629	632
35	598	598	602	600	599
40	526	530	543	532	528
45	433	437	451	441	437
50	337	340	340	344	340
55	250	256	249	259	253
60	180	189	177	187	182
65	122	124	121	127	122
70	59	67	70	69	60
75	21	22	27	22	21
80	11	11	11	11	11
85	3	3	3	3	3
90	0	0	0	0	0

Zonal Lumens		
Zone	Lumens	% Luminaire
0-10	56.1	3.5
10-20	172.0	10.7
20-30	291.1	18.0
30-40	370.9	23.0
40-50	338.0	20.9
50-60	229.2	14.2
60-70	122.3	7.6
70-80	29.9	1.9
80-90	4.4	0.3

Configuration: 4 Quadrant
Lumens/Quadrant: 403
Total Lumens: 1613
Input Watts: 19.77 W
Efficacy: 81.6 lm/W

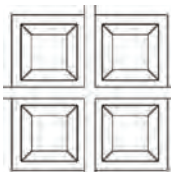

See QUAD Square Spec Sheet for Different Configurations.

QUAD TBar

Lens Options

Drop Lens

The QUAD offers a new and unique look with its drop lens option. Made from thermoformed acrylic optimum light diffusion material, the drop lens creates a dimensional look within the ceiling while providing functional lighting. Drop lens lengths available in .5", .75", and 1"



QuadT1-F-DL1"...

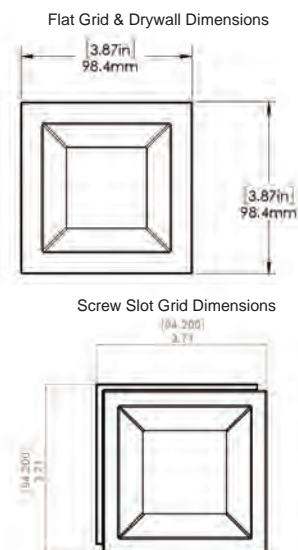

Model Tested:

QUADT1-F-DL1-500-35K8-UNV-DM-W

Zone	Lumens	% of Luminaire
0-40	187	32.7%
0-60	341	59.8%
0-90	504	88.3%
90-180	67	11.7%

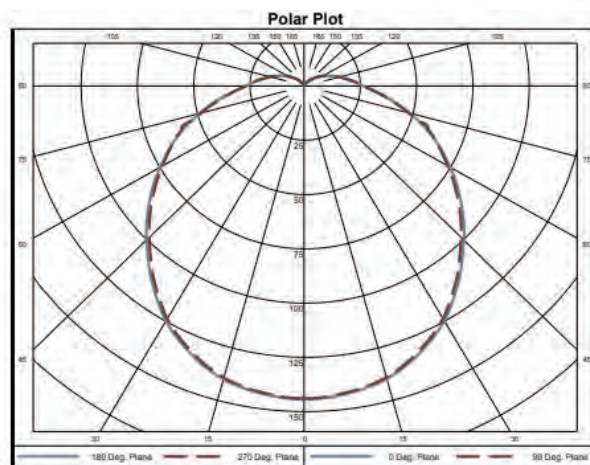

Zonal Lumen Summary

Zone	Lumens	% of Luminaire	Zone	Lumens	% of Luminaire	Zone	Lumens	% of Luminaire
0-5	3.44	0.6%	60-65	35.34	6.2%	120-125	3.64	0.6%
5-10	10.21	1.8%	65-70	32.89	5.8%	125-130	2.57	0.4%
10-15	16.72	2.9%	70-75	29.60	5.2%	130-135	1.72	0.3%
15-20	22.73	4.0%	75-80	25.49	4.5%	135-140	1.04	0.2%
20-25	28.00	4.9%	80-85	21.58	3.8%	140-145	0.53	0.1%
25-30	32.44	5.7%	85-90	17.96	3.1%	145-150	0.21	0.0%
30-35	35.72	6.3%	90-95	14.96	2.6%	150-155	0.07	0.0%
35-40	37.83	6.6%	95-100	12.37	2.2%	155-160	0.04	0.0%
40-45	38.92	6.8%	100-105	10.16	1.8%	160-165	0.04	0.0%
45-50	39.28	6.9%	105-110	8.22	1.4%	165-170	0.03	0.0%
50-55	38.73	6.8%	110-115	6.48	1.1%	170-175	0.02	0.0%
55-60	37.36	6.5%	115-120	4.95	0.9%	175-180	0.01	0.0%

Drop Lens Wattage

- 250 250 Lumens @ 5.5W
- 400 400 Lumens @ 8.9W
- 500 500 Lumens @ 11.1W
- 750 750 Lumens @ 16.7W
- 1000 1000 Lumens @ 22.2W

Lens Options

Wall Wash

General / Dimensions:

Material: Die Cast aluminum Casing, Powder Coat Finish
 Applications: Retail, Corridor, Restaurants, Commercial

Dimensions:

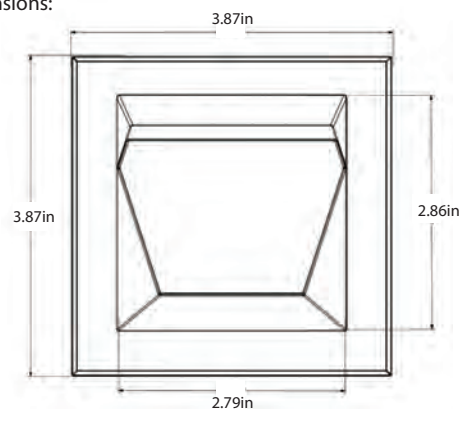

Description

The QUAD Tbar Wall Wash Quadrant allows for great illumination across the vertical plane. The QUAD Wall Wash can be specified in a multi-directional form factor - see below for proper ordering instructions and examples.

Example Product Codes:

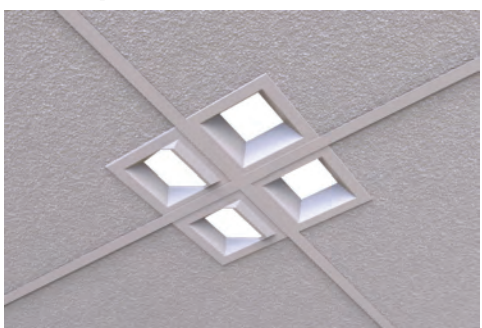

Page 1 QUAD Fixture Product Code:

QUADT1-FSQ-ARB1W35K8500-BRB1W35K8500-CWW1SW35K8500-DWW1SW35K8500-UNV-DM-W

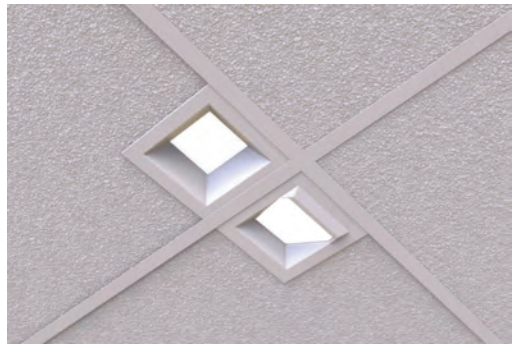

Page 1 QUAD Fixture Product Code:

QUADT1-FSQ-AX-BX-CWW1SW35K8500-DRB1W35K8500-500-B2-35K8-UNV-DM-W

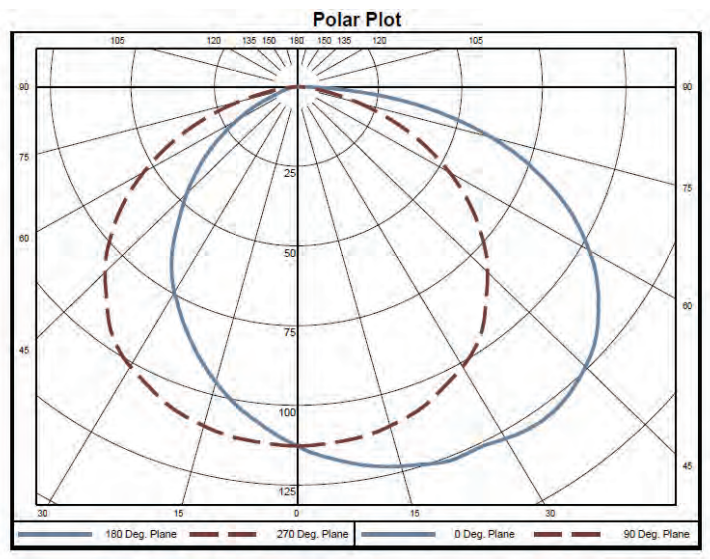

Zone	Lumens	% of Luminaire
0-40	151	41.6%
0-60	277	76.6%
0-90	361	100.0%
90-180	0	0.0%

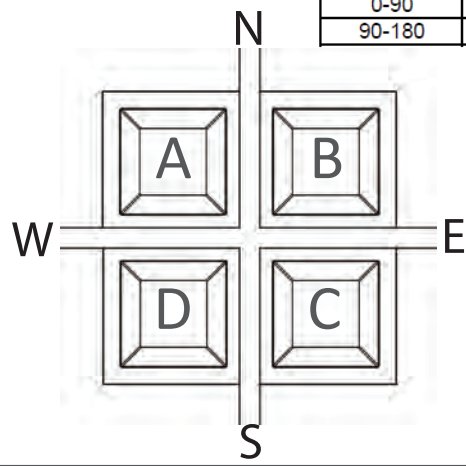

Specify Direction of the Wall Wash Quadrant In relation to the Fixture:
 For Example, if Wall Wash quadrant is specified in Quadrant C, Specify if this will face North, East, South, or West

FASTSIZE Tile Guide

FASTSIZE tiles made-to-order through your Armstrong rep

Coordinate with EC and GC for ordering tiles



The sizes you need...factory finished...one carton minimums... shipped fast!

SIZE FLEXIBILITY

- ✓ 4"-48" long and 4"-120" wide for panels
- ✓ 36"-144" for main beams
- ✓ 6"-144" for cross tees

FAST LEAD TIMES

- ✓ 3 weeks for panels
- ✓ 2 weeks for suspension systems
- ✓ 24 hours for quotes
- ✓ 24 hours for ship date confirmations

24"x24" Quad Notched Tiles

Armstrong Tile Style	Tile Lay	Armstrong Tile Number	ARON Fixture	ARON Precut Tile Number
Ultima/ Ultima High NRC	Square	1940	QUAD Square	1940-QSQ
Ultima/ Ultima High NRC	Tegular	1941	QUAD Square	1941-QSQ
Lyra PB*	Square	8372PB	QUAD Square	8372PB-QSQ
Optima PB	Square	3352	QUAD Square	3352-QSQ
Calla*	Tegular	2824	QUAD Square	2824-QSQ

* Directional Panel - Please consider direction when ordering through Armstrong

GC to Coordinate with EC and Armstrong Rep for ordering with ARON tile codes
Save on Install Time and Hassle - for any questions please contact rob.aronchick@aronlighting.com

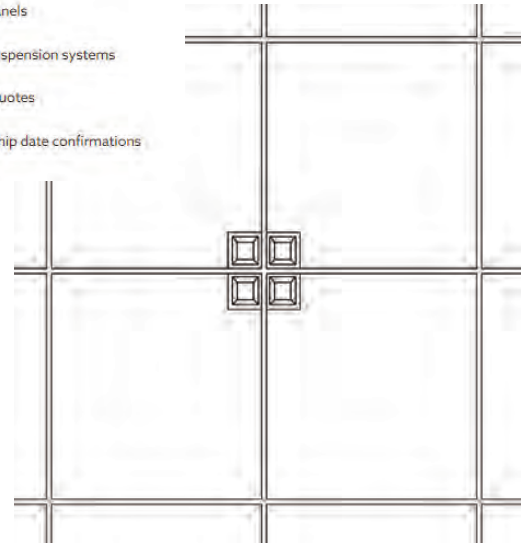

*Below ceiling view

24"x48" Quad Notched Tiles

Armstrong Tile Style	Tile Lay	Armstrong Tile Number	ARON Fixture	Con figuration	ARON Precut Tile Number
Ultima/ Ultima High NRC**	Square	1943	QUAD Square	NE/SW	1943-QSQ-NESW
Ultima/ Ultima High NRC**	Tegular	1944	QUAD Square	NE/SW	1944-QSQ-NESW
Ultima/ Ultima High NRC**	Square	1943	QUAD Square	NW/SE	1943-QSQ-NWSE
Ultima/ Ultima High NRC**	Tegular	1944	QUAD Square	NW/SE	1944-QSQ-NWSE
Lyra PB***	Square	8373PB	QUAD Square	NE/SW	8373PB-QSQ-NESW
Optima PB**	Square	3353	QUAD Square	NE/SW	3353-QSQ-NESW
Optima PB**	Square	3353	QUAD Square	NW/SE	3353-QSQ-NWSE
Calla***	Tegular	2825	QUAD Square	NE/SW	2825-QSQ-NESW
Calla***	Tegular	2825	QUAD Square	NW/SE	2825-QSQ-NWSE

** Please Notify AWI of 2x4 Panel Grid Notch

***Directional Panel - Please Consider Direction when ordering through Armstrong. Notify AWI of 2x4 Panel Grid Notch

GC to Coordinate with EC and Armstrong Rep for ordering with ARON tile codes
Save on Install Time and Hassle - for any questions please contact rob.aronchick@aronlighting.com

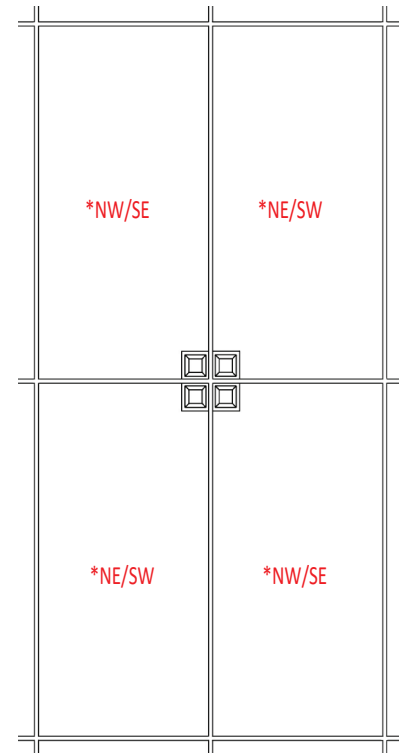

*Below ceiling view

Spotlight Ordering Guide

Beam Adjustable Ordering Code

PRODUCT ID		CCT		LUMENS		FINISH		DIMMING	
Spotlight - Field Adj	SP01	27K9	2700K - 90CRI	1200	lumens (BA)	W	White	STD	No Dim
		30K9	3000K - 90CRI			BLK	Black		
		35K9	3500K - 90CRI			SLV	Silver		
		40K9	4000K - 90CRI						



Description

The QUAD Tbar Spotlight offers a unique solution to grid mounted accent lighting. Easily mount the fixture with or without other downlight quadrants at the intersection of any TBar grid system. There are multiple configurations available, with the ability to have 4 spotlights in 1 fixture.

We have Two OEM partners for our spotlight solution. The first, by LPA, offers a field adjustable beam angle, 14-50°, with high CRI. Available in 2700K-4000K. Obtain the perfect aim illumination angle for any solution with full horizontal rotation and up to 90° verticle adjustability.

Our Second, by Bruck Lighting, Offers various static beam angles, with different lumen outputs. The GX series offers variable accent light solutions while achieving an architecturally clean look in the QUAD Tbar Housing.

No more track needed - just drop the fixture on the TBar.

GX Series Ordering Code

PRODUCT ID		CCT		LUMENS		FINISH		BEAM ANGLE		DIMMING	
Spotlight - GX	SP02	27K9	2700K - 90CRI	900	lumens (GX10)	W	White	20	20 Degrees	STD	No Dim
		30K9	3000K - 90CRI	1150	lumens (GX15)	BLK	Black	38	38 Degrees		
		35K9	3500K - 90CRI	1800	lumens (GX25)	SLV	Silver	60	60 Degrees		
		40K9	4000K - 90CRI								

Include the Quantity and Product ID on Purchase Order Beneath
QUAD Product Ordered
**** See Example Product Codes**

For More Information or Further Ordering Questions,
 Please Consult Factory

Beam Adjustable (BA) General / Dimensions:

- Light Output: Up to 1200lm
- Material: Die Cast aluminum Casing, Powder Coat Finish
- Aiming: 350° Horizontal Coverage and 90° Vertical Rotation
- Field Adjustable Beam: 14-50°
- Integral Driver
- Limited Warranty: 5 years
- LED Type: CREE CMA 1200 lm Chip

Dimensions:

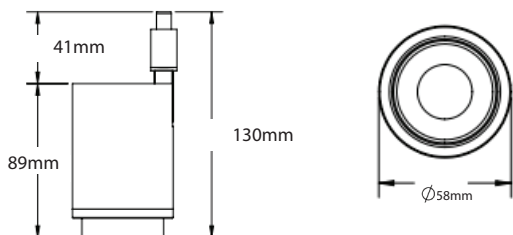

GX Series General / Dimensions:

- Light Output: 900lm, 1150lm, 1800lm Options
- Material: Die Cast aluminum Casing, Powder Coat Finish
- Aiming: 350° Horizontal Coverage and 90° Vertical Rotation
- Static Beam : 20°, 38°, 60° Options
- Integral Driver
- Limited Warranty: 5 years

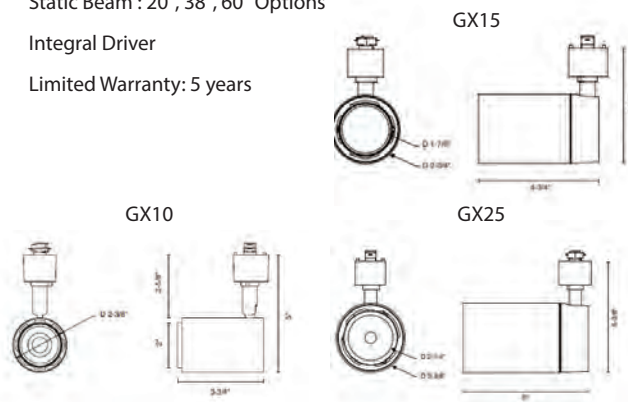

Spotlight Ordering Guide

Beam Adjustable (BA) Photometric and Performance Data

Input Voltage: 220
 Wattage: 15W
 Efficiency: 64.14 lm/W
 Current: 710mA

Polar Candela Distribution

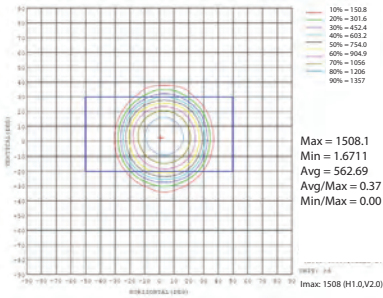

Illuminance Cone Distribution

Height	Eavg,Emax	Angle: 51.19deg	Diameter
Flux out: 732.1 lm			
1 m	979.6,15051x		95.80 cm
2 m	244.9,376.31x		191.60 cm
3 m	108.8,167.21x		287.40 cm
4 m	61.22,94.061x		383.20 cm
5 m	39.18,60.201x		479.00 cm
6 m	27.21,41.811x		574.80 cm
7 m	19.99,30.721x		670.60 cm
8 m	15.31,23.521x		766.40 cm
9 m	12.09,18.581x		862.20 cm
10 m	9.796,15.051x		958.00 cm

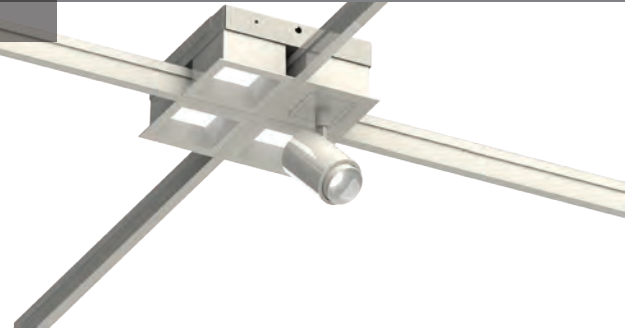

Example Product Codes:



Page 1 QUAD Fixture Product Code:

QUADT1-FSQ-ASL-BX-CX-DX-500-B2-35K8-UNV-DM-W

Page 7 Spotlight Product Code:

(qty:1) SP01-40K90-1500-W-ND

GX Series Photometric and Performance Data

GX10



Input Voltage: 120 AC
 Wattage: 10W
 Efficiency: 83 lm/W

GX15



Input Voltage: 120 AC
 Wattage: 15W
 Efficiency: 76 lm/W

GX25



Input Voltage: 120 AC
 Wattage: 22W
 Efficiency: 81 lm/W

See IES Files on www.aronlighting.com for Photometric Data on the GX10, 15, and 25



Page 1 QUAD Fixture Product Code:

QUADT1-FSQ-AR-BR-CSL-DSL-500-B2-35K8-UNV-DM-W

Page 7 Spotlight Product Code:

(qty:2) SP01-35K9-1500-W-ND

Speaker Ordering Guide

Speaker Addons	
ARON PO ID	
Sub:	SB-01
Receiver:	RE-01
Mixer:	MIX-01



General / Dimensions:

Broad Coverage Pattern: 160°

Material: Die Cast aluminum Casing, Powder Coat Finish

Driver: 60 mm (2.5 in) mid/high driver with butyl rubber surround
16-ohm allows for parallelling of multiple units on a low-Z amplifier

Applications: Retail, Corridor, Restaurants, Commercial

Grill: Many options in color and dimension for a reveal or flush aesthetic

Sub: Designed to be paired with 40CS/T subwoofer-satellite system

Dimensions:

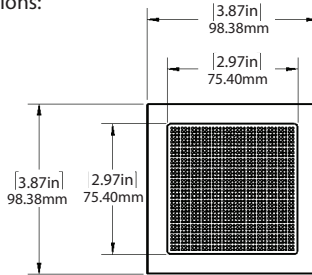

Description

The QUAD Tbar Speaker offers a unique solution to grid mounted sound solutions. Easily mount the speaker with or without other downlight quadrants at the intersection of any TBar grid system. There are multiple configurations available, recommended to have one speaker in one fixture..

No more need for cluttered ceilings at the center of the tile - just drop the fixture and speaker on the TBar. Only a single dropdown required for these various technologies!

Our speaker partner, JBL, is well renowned within the sound industry. This integrated partnership pairs great light quality with equally competitive sound quality in quite a small form factor.



Example Product Codes:



Page 1 QUAD Fixture Product Code:

QUADT1-FSQ-ASPK-BR-CR-DR-500-B2-35K8-UNV-DM-W



Page 1 QUAD Fixture Product Code:

QUADT1-FSQ-ASPK-BX-CX-DX-500-B2-35K8-UNV-DM-W

***Subwoofer, Receiver, and Mixer Available**

Speaker Ordering Guide

Specifications and Performance Data

System:

- Frequency Range (-10 dB): 140 Hz - 20 kHz
- Frequency Response (± 3 dB): 180 Hz - 17 kHz 1m/W
- Power Capacity: 30W Continuous Program Power
15W Continuous Pink Noise
- Nominal Sensitivity (2.83V/1m): 82 dB
- Nominal Coverage Angle: 160° conical coverage
- Directivity Factor (Q): 6.6
- Directivity Index (DI): 6.8 dB
- Rated Maximum SPL: 94 dB @ 1m (3.3 ft) average, 114 dB peak
- Rated Impedance: 16 ohms

Transducer

- Driver: 60 mm (2.5 in) with polypropylene cone, butyl rubber surround, copper-clad coil, vented aluminum former



Beamwidth:

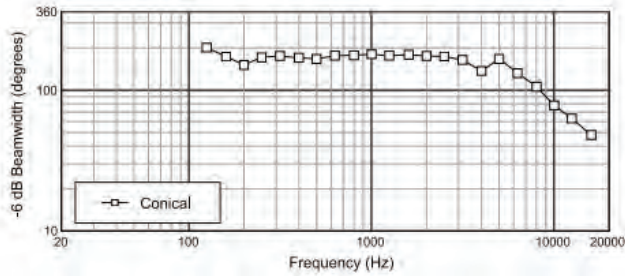

Frequency Response:

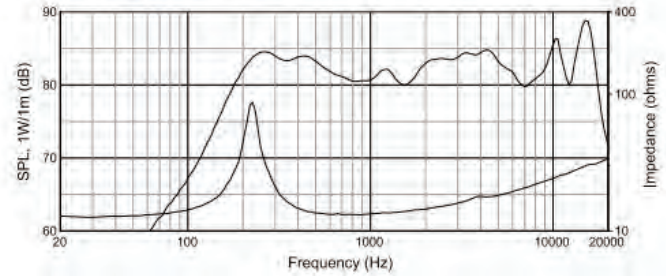

Half-space (2pi, mounted in ceiling)

Directivity Index:

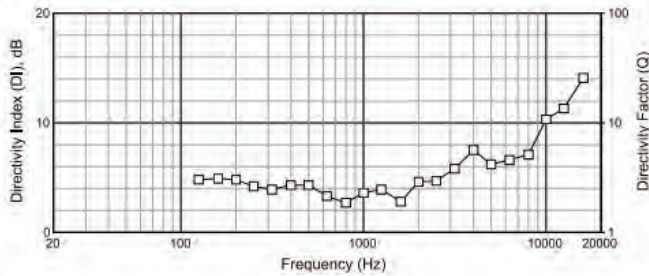

Off-Axis Frequency Response:

