

QUAD TBar

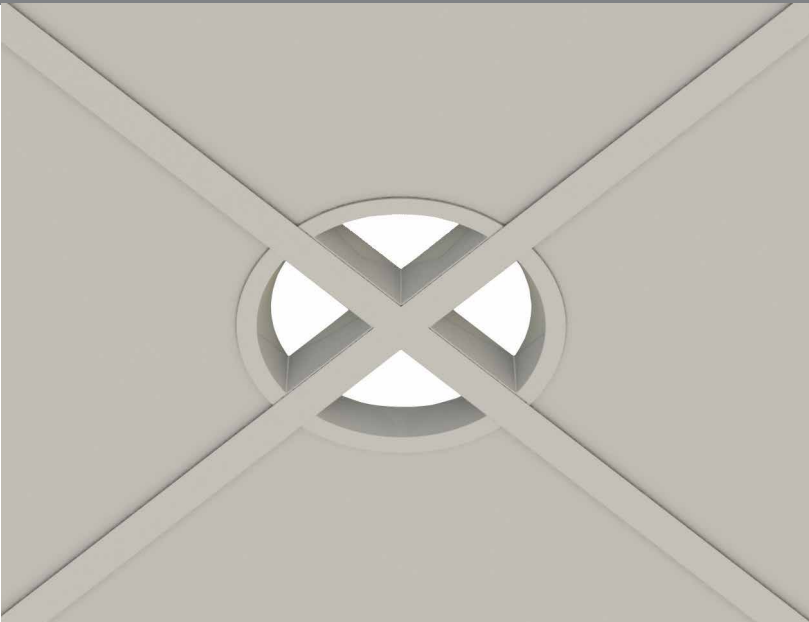

Project: _____

Type: _____

Notes: _____

The **QUAD** Luminaire features a Patent-Pending mounting system over the intersection of the ceiling grid. The Quad is a modular Downlight fixture that allows for different configurations based on optical and aesthetic requirements.

Shown: QuadT1-FR-ARW-BRW-CRW-DRW-...



Patent Pending
5 Year Warranty

Ordering Guide



QuadT1							
ARON ID	CEILING TYPE/SHAPE	QUADRANT A	QUADRANT B	QUADRANT C	QUADRANT D	LUMENS PER QUADRANT	
QuadT1	FR Flat Grid Round Quadrants	ARW Regressed Lens-Static White	BRW Regressed Lens-Static White	CRW Regressed Lens-Static White	DRW Regressed Lens-Static White	125	125 Lumens per Quadrant
		ARC Regressed Lens RGBW	BRC Regressed Lens RGBW	CRC Regressed Lens RGBW	DRC Regressed Lens RGBW	250	250 Lumens per Quadrant
	DW Drywall Round Quadrants	AX No Quadrant	BX No Quadrant	CX No Quadrant	DX No Quadrant	400	400 Lumens per Quadrant
						500	500 Lumens per Quadrant
						750	750 Lumens per Quadrant

BEAM		COLOR / CRI		UNV		DM		FINISH		OPTIONS	
				VOLTAGE		DRIVER					
B1	Narrow	27K8	2700K - 80CRI	UNV	120 - 277V	DM	Factory 0-10V Dim 1%	W	White	E5W	5W EM Battery
B2	Medium	30K8	3000K - 80CRI					C	Custom Color	E10W	10W EM Battery
B3	Wide	35K8	3500K - 80CRI							CP	Chicago Plenum
B4	Asymmetric	40K8	4000K - 80CRI								
		27K9	2700K - 90CRI								
		30K9	3000K - 90CRI								
		35K9	3500K - 90CRI								
		40K9	4000K - 90CRI								
		RGBW	RGBW - specify color temp of W								

Ordering Instructions

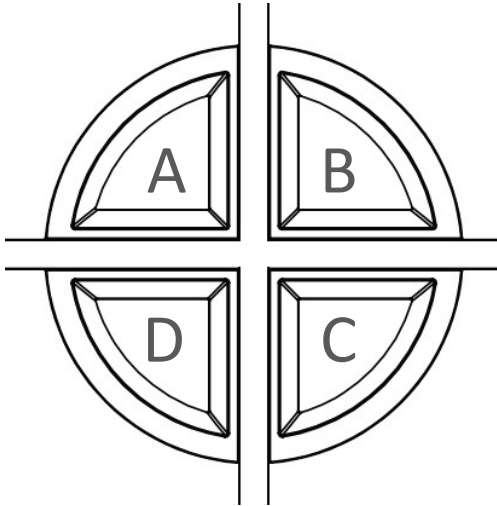

- Match labeled quadrant with corresponding column on ordering guide.
- Notate "R" to use quadrant with regressed lens.
- Notate "X" to omit quadrant from fixture.

Notes:

- Coordinate lighting fixture install with ceiling contractor
- Contact your local Armstrong representative for Made-To-Order ceiling tiles. (See page 6)

Sample Configurations

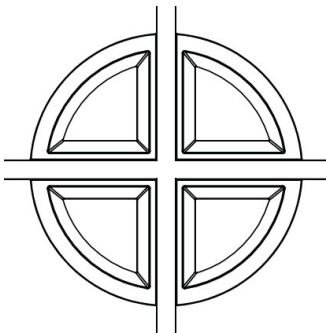

QuadT1-FR-AR-BR-CR-DR

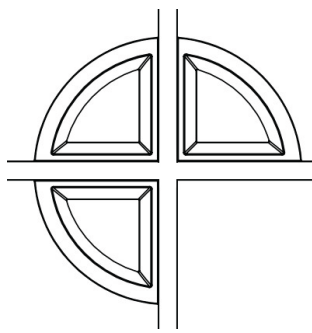

QuadT1-FR-AR-BR-CX-DR

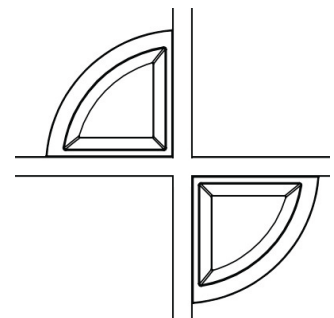

QuadT1-FR-AR-BX-CR-DX

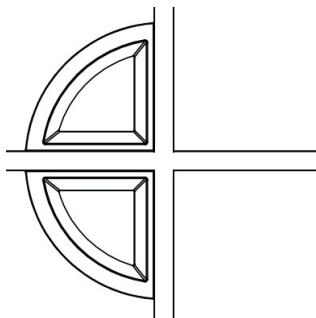

QuadT1-FR-AR-BX-CX-DR

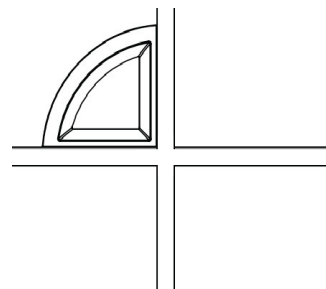

QuadT1-FR-AR-BX-CX-DX

Housing Types

Flat Housing

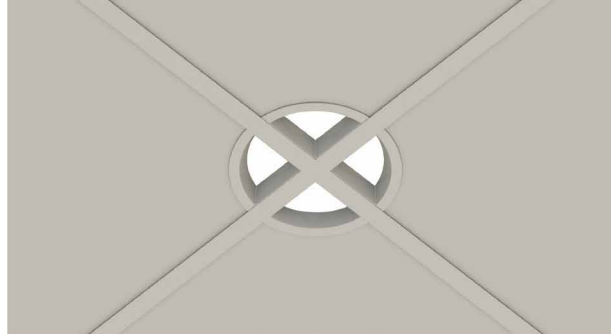

- Notate "FR" in Ordering Guide
- Designed for Flat 9/16" & 15/16" Grids

Dimensions

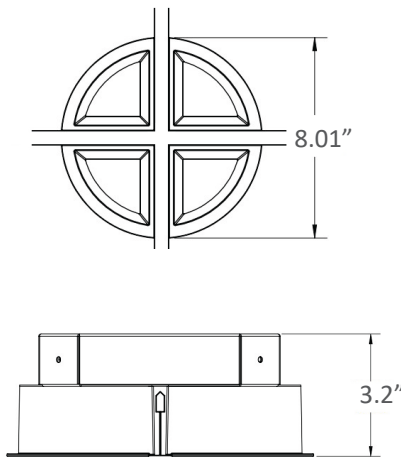

Flat Housing

Construction

- Cast Aluminum housing
- Powder coated paint
- Galvanized sheet metal components
- Mate with Flat 15/16", 9/16" and Dimensional 9/16" TBars

Optical

- Symmetric and asymmetric distributions
- Coated Acrylic light guide
- Coated Acrylic diffuser
- Minimum 80 or 90 CRI
- 3000K, 3500K, 4000K
- ≤ 3 SDCM

Electrical

- Integral high efficiency driver
- 0-10V dimming (1%) standard
- Class 2

Weight

- 4Q = 10 lbs
- 3Q = 8.5 lbs
- 2Q = 7.0 lbs
- 1Q = 5.5 lbs

QUAD TBar

Beam Options

Contact factory for custom configurations

4, 3, 2D, 1 Quadrant Configurations

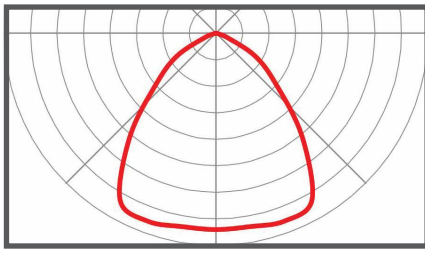
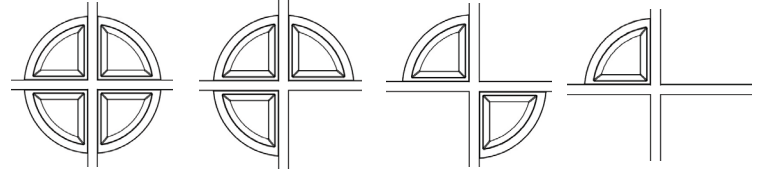

B1 - Narrow

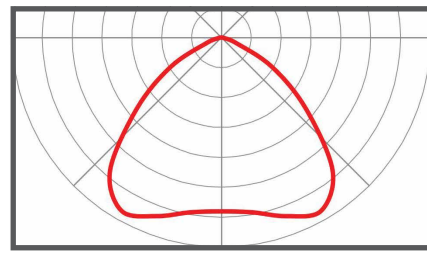

B2 - Medium

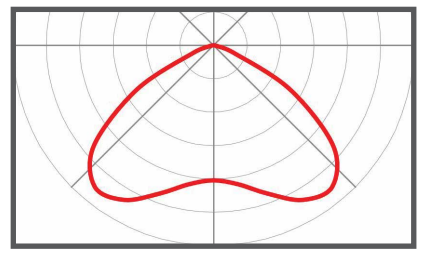

B3- Wide

2 Quadrant Parallel

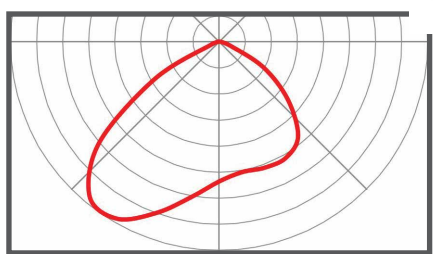

B4- Asymmetric

Fixture Wattages

Lumens/Fixture	Watts/Fixture
250	3.0
500	6.0
1000	12.0
1500	18.1
2000	24.1

Bluetooth Technology



BubblyNet

With our BubblyNet OEM partnership, realize the power of bluetooth lighting control! Offering wall controllers, integrated fixture sensors, tunable white/ rgbw control. Contact Factory for More Information



PoE Technology

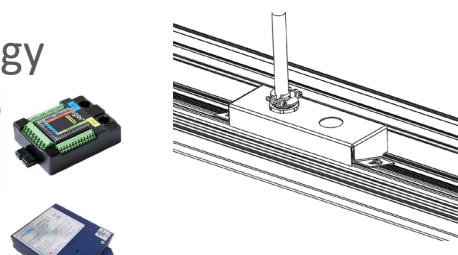

Our Partnerships with Igor and NuLEDs offer PoE Integration using low voltage cat 5, cat 6 cabling. Contact Factory For more Information.

Model Tested: QuadT1-FR-AR-BR-CR-DR-400-B2-35K8-UNV-DM-W

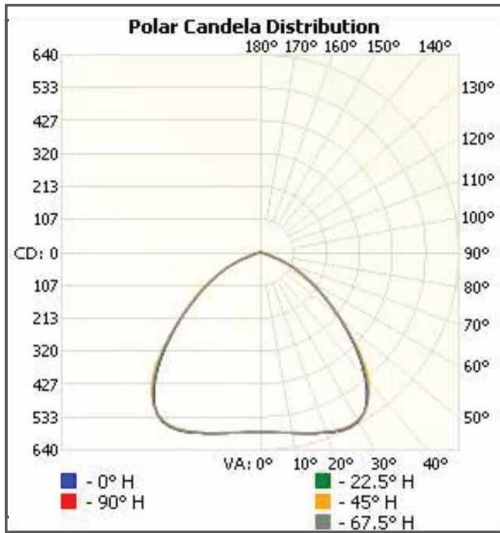

Configuration: 4 Quadrant
Lumens/Quadrant: 403
Total Lumens: 1613
Input Watts: 19.77 W
Efficacy: 81.6 lm/W

Vertical Angle	Horizontal Angles				
	0	22.5	45	67.5	90
0	582	582	582	582	582
5	585	585	585	584	585
10	594	593	593	592	593
15	606	606	604	604	606
20	620	620	618	619	621
25	633	632	629	631	633
30	631	629	628	629	632
35	598	598	602	600	599
40	526	530	543	532	528
45	433	437	451	441	437
50	337	340	340	344	340
55	250	256	249	259	253
60	180	189	177	187	182
65	122	124	121	127	122
70	59	67	70	69	60
75	21	22	27	22	21
80	11	11	11	11	11
85	3	3	3	3	3
90	0	0	0	0	0

Zonal Lumens		
Zone	Lumens	% Luminaire
0-10	56.1	3.5
10-20	172.0	10.7
20-30	291.1	18.0
30-40	370.9	23.0
40-50	338.0	20.9
50-60	229.2	14.2
60-70	122.3	7.6
70-80	29.9	1.9
80-90	4.4	0.3

Model Tested: QuadT1-FR-AR-BX-CX-DR-400-B4-35K8-UNV-DM-W

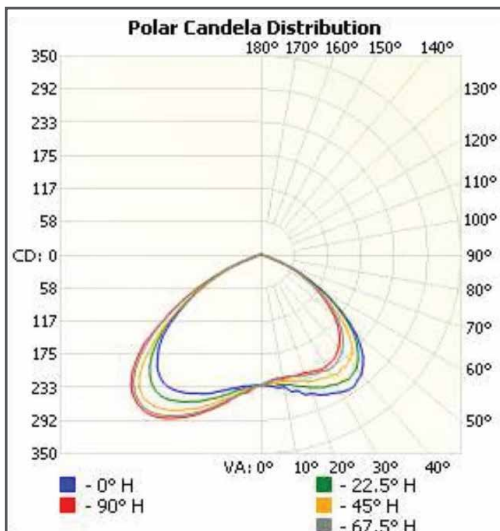

Configuration: 2 Quadrant Parallel
Lumens/Quadrant: 422
Total Lumens: 845
Input Watts: 9.76 W
Efficacy: 86.6 lm/W

Vertical Angle	Horizontal Angles				
	0	22.5	45	67.5	90
0	229	229	229	229	229
5	232	225	227	223	221
10	236	233	226	223	219
15	247	239	229	221	220
20	260	248	237	225	221
25	271	257	241	230	226
30	279	264	244	234	227
35	283	267	244	231	223
40	273	260	241	221	212
45	253	240	225	202	194
50	218	210	190	174	168
55	170	166	146	140	134
60	122	120	105	104	100
65	76	76	68	68	67
70	33	38	38	37	34
75	13	13	16	14	14
80	7	7	7	8	8
85	2	2	2	3	3
90	0	0	0	0	0

Zonal Lumens		
Zone	Lumens	% Luminaire
0-10	22.3	2.6
10-20	70.5	8.3
20-30	125.3	14.8
30-40	177.5	21
40-50	197.1	23.3
50-60	155.2	18.4
60-70	77.3	9.1
70-80	17.2	2
80-90	2.9	0.3

Made-To-Order Tile Guide

Pre-cut tiles made-to-order through your Armstrong rep

Coordinate with EC and GC for ordering tiles

24"x24" Quad Notched Tiles

Armstrong Tile Style	Tile Lay	Armstrong Tile Number	ARON Fixture	ARON Precut Tile Number
Ultima/ Ultima High NRC	Square	1940	QUAD Round	1940-QRD
Ultima/ Ultima High NRC	Tegular	1941	QUAD Round	1941-QRD
Lyra PB	Square	8372PB	QUAD Round	8372PB-QRD
Optima PB	Tegular	3354	QUAD Round	3354-QRD
Optima PB	Square	3352	QUAD Round	3352-QRD
Cala	Tegular	2824	QUAD Round	2824-QRD

GC to Coordinate with EC and Armstrong Rep for ordering with ARON tile codes
 Save on Install Time and Hastle - for any questions please contact rob.aronchick@aronlighting.com

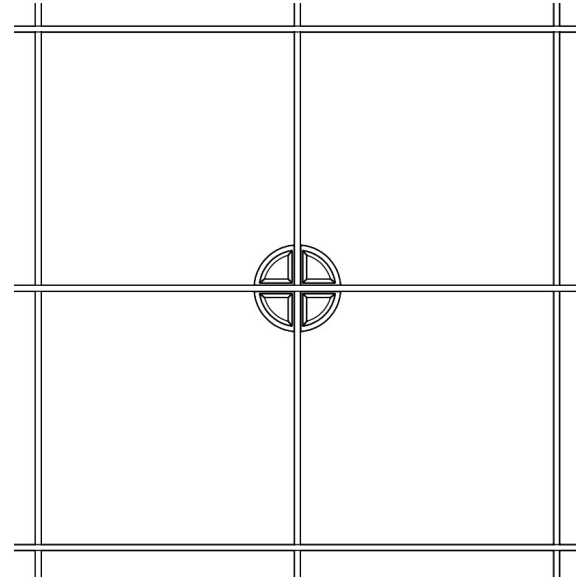

*Below ceiling view

24"x48" Quad Notched Tiles

Armstrong Tile Style	Tile Lay	Armstrong Tile Number	ARON Fixture	Con figuration	ARON Precut Tile Number
Ultima/ Ultima High NRC	Square	1943	QUAD Round	NE/SW	1943-QRD-NESW
Ultima/ Ultima High NRC	Tegular	1944	QUAD Round	NE/SW	1944-QRD-NESW
Ultima/ Ultima High NRC	Square	1943	QUAD Round	NW/SE	1943-QRD-NWSE
Ultima/ Ultima High NRC	Tegular	1944	QUAD Round	NW/SE	1944-QRD-NWSE
Lyra PB	Square	8373PB	QUAD Round	NE/SW	8373PB-QRD-NESW
Lyra PB	Tegular	8373PB	QUAD Round	NW/SE	8363PB-QRD-NWSE
Optima PB	Square	3353	QUAD Round	NE/SW	3353-QRD-NESW
Optima PB	Tegular	3252	QUAD Round	NE/SW	3252-QRD-NESW
Optima PB	Square	3353	QUAD Round	NW/SE	3353-QRD-NWSE
Optima PB	Tegular	3252	QUAD Round	NW/SE	3252-QRD-NWSE
Calla	Tegular	2825	QUAD Round	NE/SW	2825-QRD-NESW
Calla	Tegular	2825	QUAD Round	NW/SE	2825-QRD-NWSE

GC to Coordinate with EC and Armstrong Rep for ordering with ARON tile codes
 Save on Install Time and Hastle - for any questions please contact rob.aronchick@aronlighting.com

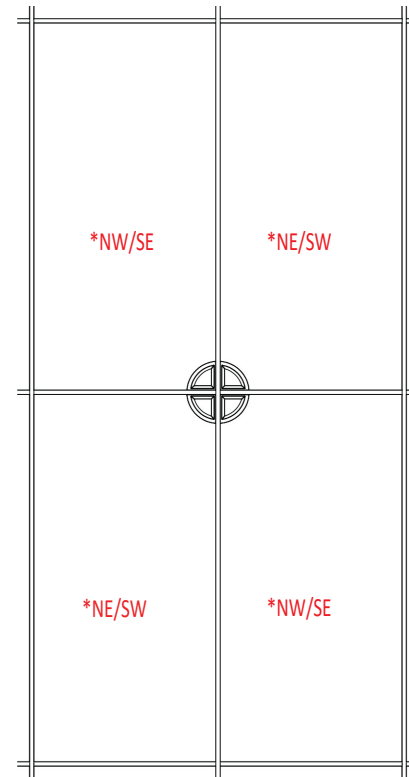

*Below ceiling view